

SZB IT 19" NETWORK/SERVER CABINETS

DESCRIPTION

STANDARD CABINETS WITH FRONT GLASS DOOR WITH METAL SIDES

available in constant supply from warehouse

SCOPE OF DELIVERY

- Bolted frame (bottom plate, top plate, four posts).
- Front glass door with metal sides and lock with swing handle; cabinets 45 or 42 U high have a three-point lock, cabinets 24 U high have a single-point lock.
- Rear solid metal, shortened door with single-point locks without handle; 3U cable entry panel with a brush strip, mounted under the shortened door.
- Two solid metal side panels with single-point locks.
- Two pairs of 19" mounting profiles, type STANDARD, stepless adjustable.
- Earthing bar and earthing conductors for doors and side panels.
- Four levelling feet.

TECHNICAL DATA

Material

Frame, side panels, solid metal door, mounting profiles, C-profiles - sheet steel.

Door with glass - sheet steel, clear mineral safety glass
Outriggers - zamak casting.

Protection degree

IP 20 in accordance with EN 60529
(does not apply to brush cable entries).

Surface finishing

Frame, doors, side panels
- powder paint, light grey (RAL 7035).
Mounting profiles, C-profiles
- Al-Zn coated.

Maximum load capacity

See page 30

REFERENCE CHART

Height [U]	Width [mm]	Depth [mm]	RAL colour	Catalogue number	
24 U	600	600	7035	WZ-IT-246060-69AA-2-011	
		800	7035	WZ-IT-246080-69AA-2-011	
	800	600	7035	WZ-IT-248060-69AA-2-011	
		800	7035	WZ-IT-248080-69AA-2-011	
42 U	600	600	7035	WZ-IT-426060-69AA-2-011	
		800	7035	WZ-IT-426080-69AA-2-011	
	800	600	7035	WZ-IT-428060-69AA-2-011	
		800	7035	WZ-IT-428080-69AA-2-011	
	45 U	600	600	7035	WZ-IT-456060-69AA-2-011
		800	800	7035	WZ-IT-458080-69AA-2-011

Other available configurations are presented on pages 30-31

ADVANTAGES

- Cable openings in the top and bottom plates, 71 mm wide, what allows to put through the power cords with three-phase plug.
- All openings in the top and bottom plates blanked with knock-out blanking plates.
- U-marking on the mounting profiles.
- Maximum opening angle for front door – 270°
- Possibility to change door opening's direction.
- Possibility to put the cabinet directly on the floor (no protruding elements under the cabinet).
- Adaptation for bying the cabinets in the rows.

ACCESSORIES from page 59

- **Roof** page 74
- **Plinth, castors** page 60
- **Fan units** page 88
- **Blanking and cable entry plates** page 75
- **Power strips** page 96
- **Shelves** page 64
- **Mounting guides** page 71
- **Cable trays** page 83
- **Masking panels** page 77



View on the top plate

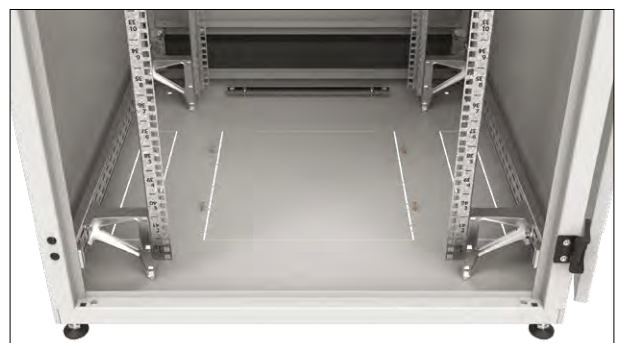

View on the bottom plate. Under the rear door is mounted 3U cable entry panel with a brush strip.

NETWORK/SERVER CABINETS **SZB IT 19"**

DESCRIPTION



Hinges enabling opening door by 270°

Holes for baying cabinets in a row



Three-point rod-latch lock with a swing handle

Additional holes for hinges, allowing to change the door opening direction

Cabinet 600 mm wide



Cabinet 800 mm wide

U-marking on the mounting profiles



max 270°

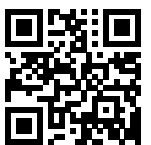

See the video:
zpas.pl/qr/f10

SZB IT 19" NETWORK/SERVER CABINETS

DESCRIPTION

STANDARD CABINETS WITH PERFORATED DOOR

available in constant supply from warehouse

SCOPE OF DELIVERY

- Bolted frame (bottom plate, top plate, four posts).
- Front and rear perforated metal door (clearance 80%, proportion of the perforated area in total door area up to 86%) with three-point lock with swing handle.
- Two solid metal side panels with single-point locks.
- Two pairs of 19" mounting profiles, type STANDARD, stepless adjustable.
- Earthing bar.
- Earthing conductors for doors and side panels.
- Four levelling feet.

TECHNICAL DATA

Material

Frame, side panels, doors, mounting profiles, C-profiles - sheet steel.
Outriggers - zamak casting.

Protection degree

IP 20 in accordance with EN 60529 (does not apply to brush cable entries).

Surface finishing

Frame, doors, side panels
- powder paint, light grey (RAL 7035) or black (RAL 9005).
Mounting profiles, C-profiles
- Al-Zn coated.

Maximum load capacity

See page 30

ACCESSORIES from page 59

- **Roof** page 74
- **Plinth, castors** page 60
- **Fan units** page 88
- **Blanking and cable entry plates** page 75
- **Power strips** page 96
- **Shelves** page 64
- **Mounting guides** page 71
- **Cable trays** page 83
- **Masking panels** page 77

REFERENCE CHART

Height [U]	Width [mm]	Depth [mm]	RAL colour	Catalogue number
42 U	600	1000	7035	WZ-IT-426010-44AA-2-011
			9005	WZ-IT-426010-44AA-2-161
	800	1000	7035	WZ-IT-428010-44AA-2-011
			9005	WZ-IT-428010-44AA-2-161

Other available configurations are presented on pages 30-31

ADVANTAGES

- Cable openings in the top and bottom plates, 71 mm wide, what allows to put through the power cord with three-phase plug.
- All openings in the top and bottom plates blanked with knock-out blanking plates.
- U-marking on the mounting profiles.
- Maximum opening angle for front and rear door – 270°
- Possibility to change door opening's direction.
- Possibility to put the cabinet directly on the floor (no protruding elements under the cabinet).
- Adaptation for bying the cabinets in the rows and Data Box creation (cold/hot aisle).

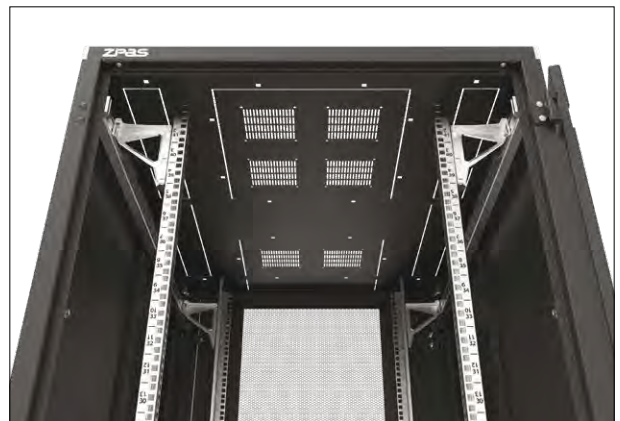

View on the top plate



View on the bottom plate

NETWORK/SERVER CABINETS **SZB IT 19"**

DESCRIPTION



Hinges enabling opening door by 270°

Holes for baying cabinets in a row



Additional holes for hinges, allowing to change the door opening direction

Cabinet 600 mm wide



Cabinet 800 mm wide

U-marking on the mounting profiles



Three-point rod-latch lock with a swing handle

max 270°

SZB IT 19" NETWORK/SERVER CABINETS

DESIGN

A-A section
(800 mm deep cabinet)

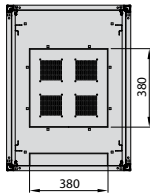

B-B section
(800 mm deep cabinet)

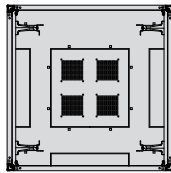

DESIGN

1. Frame's post
3. Frame's bottom plate
4. Frame's top plate
5. Adjustable feet
6. C-profile for 15 mm deep mounting profiles
7. Outrigger
8. 19" mounting profile, type STANDARD, 15 mm deep
9. Earthing bar
10. Knock-out blanking plate 380 x 380 mm
12. Knock-out blanking plate 380 x 71 mm

Note:

The cabinet in the drawing is shown without any panels or doors.

A-A section
(600 mm deep cabinet)

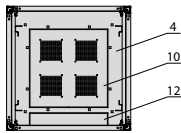

B-B section
(600 mm deep cabinet)

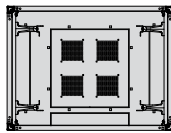

Front view
(600 mm wide cabinet)

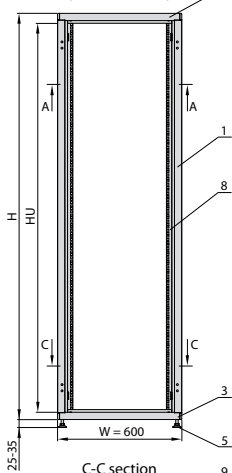

Front view
(800 mm wide cabinet)

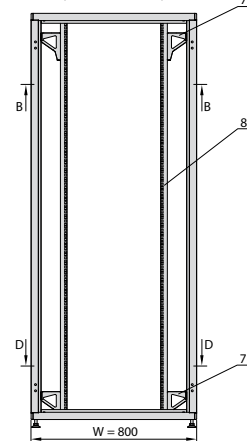

Side view
(600 mm deep cabinet)

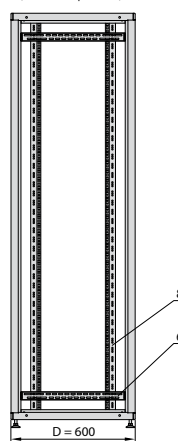

Side view
(800 mm deep cabinet)

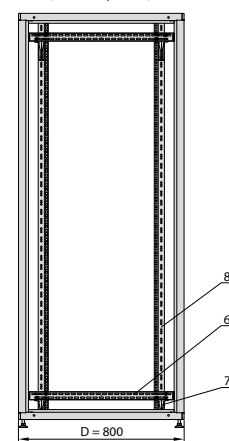

C-C section
(600 mm deep cabinet)

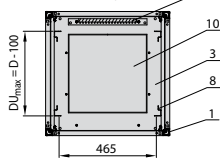

D-D section
(600 mm deep cabinet)

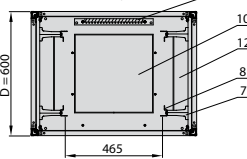

C-C section
(800 mm deep cabinet)

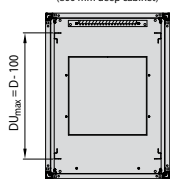

D-D section
(800 mm deep cabinet)

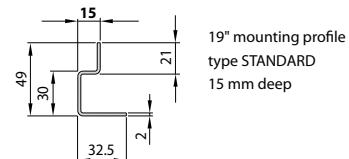
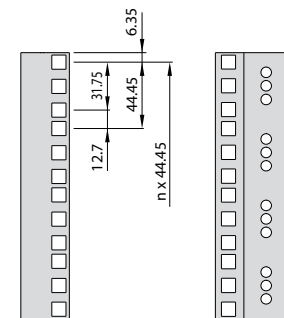
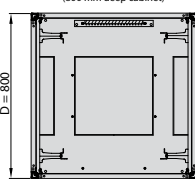

NETWORK/SERVER CABINETS **SZB IT 19"**

DESIGN

DESIGN

1. Frame's post
2. Frame's middle post
3. Frame's bottom plate
4. Frame's top plate
5. Adjustable feet
6. C-profile for 12 mm deep mounting profiles
7. Outrigger
8. 19" mounting profile, type PREMIUM*, 12 mm deep
9. Earthing bar
10. Knock-out blanking plate 380 x 380 mm
11. Knock-out blanking plate 380 x 210 mm
12. Knock-out blanking plate 380 x 71 mm

Note:
The cabinet in the drawing is shown without any panels or doors.

*) Cabinets in standard configuration (see pages 26-27) are equipped with STANDARD type of mounting profiles.

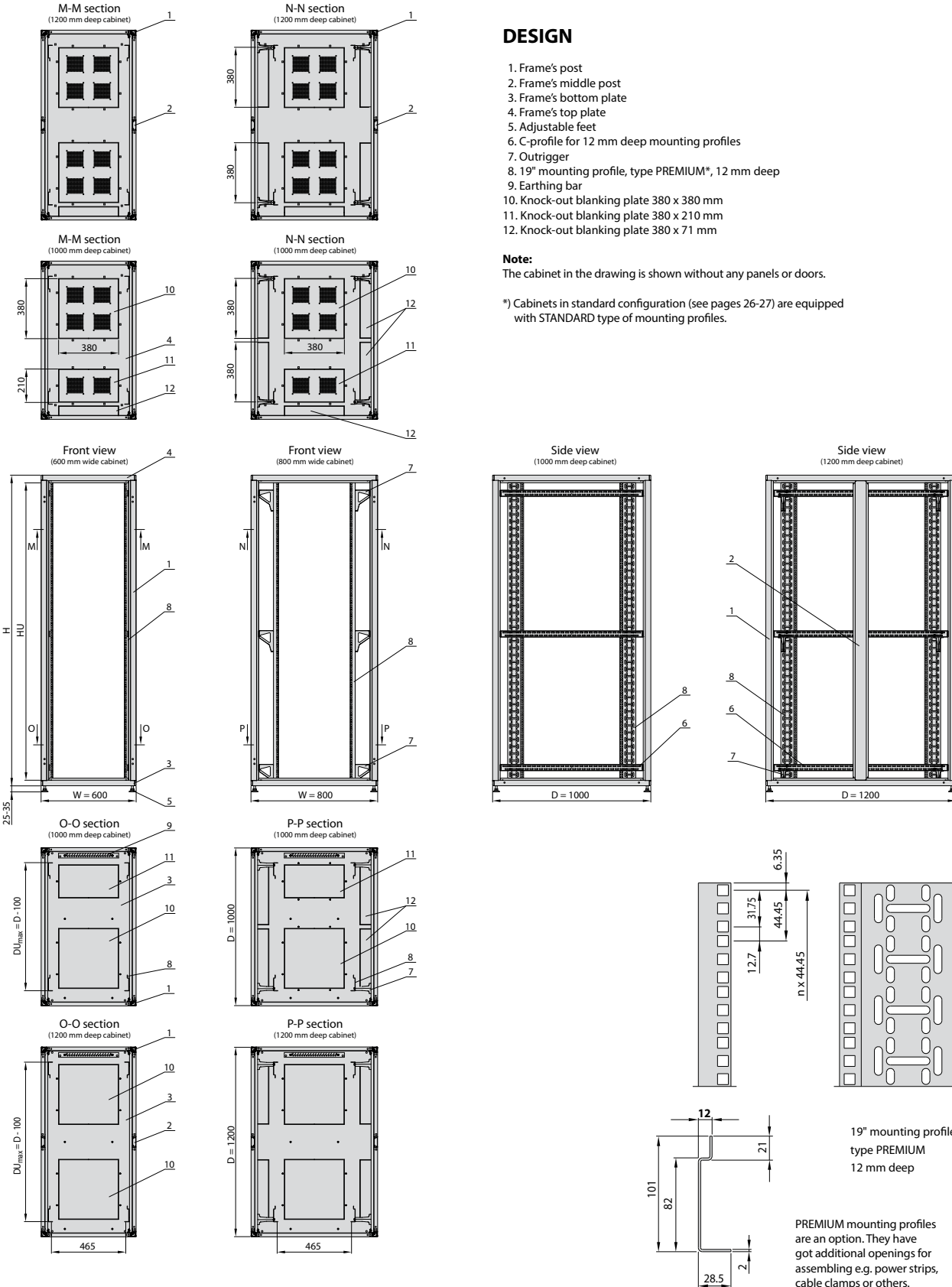

SZB IT 19" NETWORK/SERVER CABINETS

CONFIGURATOR

REFERENCE CHART

Width W [mm]	Depth D [mm]	Reference number					
		600	600	186060	246060	336060	426060
600	800	186080	246080	336080	426080	456080	—
	1000	—	246010	—	426010	456010	476010
	1200	—	—	—	426012	456012	476012
	600	188060	248060	338060	428060	458060	—
800	800	188080	248080	338080	428080	458080	—
	1000	—	248010	—	428010	458010	478010
	1200	—	—	—	428012	458012	478012
	Usable height HU [U = 44.45 mm]		18 U	24 U	33 U	42 U	45 U
Frame height H [mm]		896	1163	1563	1963	2096	2186

Note: Cabinets available in constant supply from warehouse are listed and described on pages 24-27.

CATALOGUE NUMBER OF SZB IT CABINET

WZ-IT-XXXXXXXX-XXXX-X-XXX

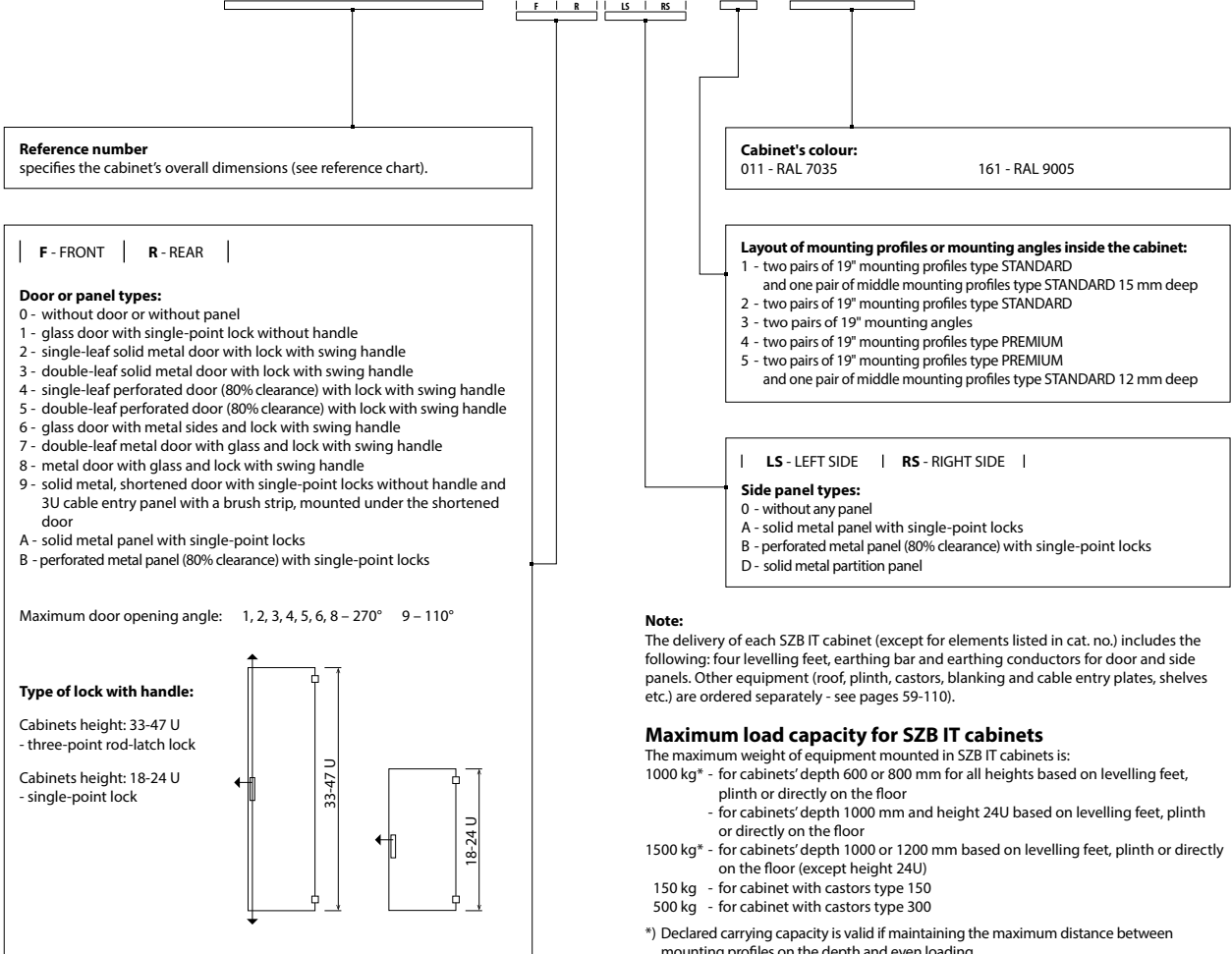

NETWORK/SERVER CABINETS **SZB IT 19"**

CONFIGURATOR

AVAILABLE DOOR TYPES AND PANELS



[1] Glass door

[2] Single-leaf solid metal door

[3] Double-leaf solid metal door

[4] Single-leaf perforated door (80% clearance)

[5] Double-leaf perforated door (80% clearance)

[6] Glass door with metal sides



[7] Double-leaf metal door with glass

[8] Metal door with glass

[9] Solid metal, shortened door + 3U cable entry panel with a brush strip

[A] Solid metal panel

[B] Perforated metal panel (80% clearance)

[D] Solid metal partition panel

SZB/DSR IT 19" SERVER CABINETS

COLD AISLE INSTALLATIONS

Cold aisle installation

The **SZB IT Data Box** solution physically separates the air distributed by air conditioners and the hot air generated by operating equipment.

SZB IT Data Box optimises the usability of the data centre infrastructure.



Example of Data Box set consists of 12 pcs of SZB IT 47 U, 800 x 1200 mm, sliding doors and raised aisle roof. Cabinets without feet. Cable tray on the roof.



Example of Data Box set consists of:
4 pcs of SZB IT 42 U, 800 x 1000 mm,
2 pcs of DSR IT 42 U, 800 x 1000 mm with 2 compartments,
2 pcs of DSR IT 42 U, 800 x 1000 mm with 4 compartments,
sliding doors, flat aisle roof.
Cabinets on 100 mm plinth.

SERVER CABINETS **SZB/DSR IT 19"**

COLD AISLE INSTALLATIONS

Cold aisle sliding door

Manual sliding glass doors without a lock. Opened along the entire width of the aisle. Supplied with a roof masking panel and cabinet side panels.
Designed for cold aisle **1200 mm** wide.

Material

Aluminium profiles; safety glass; sheet steel powder painted in light grey (RAL 7035) or black (RAL 9005).

Scope of delivery

Two sliding door leaves with rails, runners and self-closer, two or four cabinet side panels (depending on the depth of the cabinets), aisle roof masking panel, fixing accessories.



WZ-8848-01-03-161
Cold aisle sliding door for Data Box 47 U, 1200 mm, without feet or plinth, with raised roof



WZ-8848-01-06-161
Cold aisle sliding door for Data Box 42 U, 1000 mm, with plinth and flat roof



WZ-8848-01-06-161
Cold aisle sliding door for Data Box 47 U, 1200 mm, with feet and raised roof

For Data Box cabinets¹		Catalogue number			
		Sliding door for aisle with raised roof		Sliding door for aisle with flat roof	
height	depth	RAL 7035	RAL 9005	RAL 7035	RAL 9005
42 U without feet or plinth	1000	WZ-8848-20-01-011	WZ-8848-20-01-161	WZ-8848-30-01-011	WZ-8848-30-01-161
	1200	WZ-8848-01-01-011	WZ-8848-01-01-161	WZ-8848-45-01-011	WZ-8848-45-01-161
47 U without feet or plinth	1000	WZ-8848-20-03-011	WZ-8848-20-03-161	WZ-8848-30-03-011	WZ-8848-30-03-161
	1200	WZ-8848-01-03-011	WZ-8848-01-03-161	WZ-8848-45-03-011	WZ-8848-45-03-161
42 U with feet	1000	WZ-8848-20-04-011	WZ-8848-20-04-161	WZ-8848-30-04-011	WZ-8848-30-04-161
	1200	WZ-8848-01-04-011	WZ-8848-01-04-161	WZ-8848-45-04-011	WZ-8848-45-04-161
47 U with feet	1000	WZ-8848-20-06-011	WZ-8848-20-06-161	WZ-8848-30-06-011	WZ-8848-30-06-161
	1200	WZ-8848-01-06-011	WZ-8848-01-06-161	WZ-8848-45-06-011	WZ-8848-45-06-161
42 U with plinth	1000	WZ-8848-20-07-011	WZ-8848-20-07-161	WZ-8848-30-07-011	WZ-8848-30-07-161
	1200	WZ-8848-01-07-011	WZ-8848-01-07-161	WZ-8848-45-07-011	WZ-8848-45-07-161
47 U with plinth	1000	WZ-8848-20-09-011	WZ-8848-20-09-161	WZ-8848-30-09-011	WZ-8848-30-09-161
	1200	WZ-8848-01-09-011	WZ-8848-01-09-161	WZ-8848-45-09-011	WZ-8848-45-09-161

Package: 1 set

SZB/DSR IT 19" SERVER CABINETS

COLD AISLE INSTALLATIONS

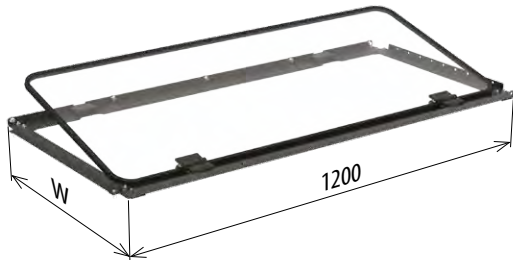

Cold aisle flat roof

Flat roof module for 1200 mm wide cold aisle. The transparent part of the module is tiltable. The modular design allows easy expansion and installation of lighting.

Material

Transparent plastic (polycarbonate); sheet steel powder painted in light grey (RAL 7035) or black (RAL 9005).

Scope of delivery

Roof module with fixing accessories.

Width W [mm]	Catalogue number	
	RAL 7035	RAL 9005
300	WZ-8848-60-04-011	WZ-8848-60-04-161
400	WZ-8848-60-05-011	WZ-8848-60-05-161
600	WZ-8848-60-02-011	WZ-8848-60-02-161
800	WZ-8848-60-01-011	WZ-8848-60-01-161

Package: 1 pc.

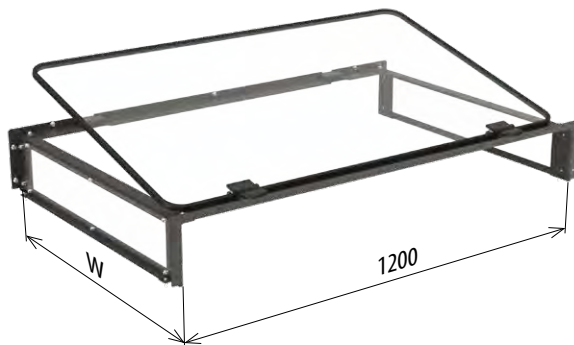

Cold aisle raised roof

Roof module with internal height of 150 mm for 1200 mm wide cold aisle. The top transparent element of the module is tiltable. The modular design allows easy expansion and installation of lighting.

Material

Transparent plastic (polycarbonate); sheet steel powder painted in light grey (RAL 7035) or black (RAL 9005).

Scope of delivery

Roof module with fixing accessories.

Width W [mm]	Catalogue number	
	RAL 7035	RAL 9005
300	WZ-8848-40-04-011	WZ-8848-40-04-161
400	WZ-8848-40-05-011	WZ-8848-40-05-161
600	WZ-8848-40-02-011	WZ-8848-40-02-161
800	WZ-8848-40-01-011	WZ-8848-40-01-161

Package: 1 pc.

SERVER CABINETS **SZB/DSR IT 19"**

COLD AISLE INSTALLATIONS

Partition panel for cabinets baying in row

Side panel of the cabinet adapted as partition between cabinets baying in row. It is with four openings for clamp connectors bolts.

Material

Sheet steel powder painted in light grey (RAL 7035) or black (RAL 9005).

Scope of delivery

One-piece or two-piece complete partition panel with locks, fixing pins and an earthing conductor.

For cabinets'		Catalogue number	
height	depth	RAL 7035	RAL 9005
42 U	1200	WZ-8848-24-4212-011	WZ-8848-24-4212-161
	1000	WZ-8848-24-4210-011	WZ-8848-24-4210-161
47 U	1200	WZ-8848-24-4712-011	WZ-8848-24-4712-161
	1000	WZ-8848-24-4710-011	WZ-8848-24-4710-161

Package: 1 pc.

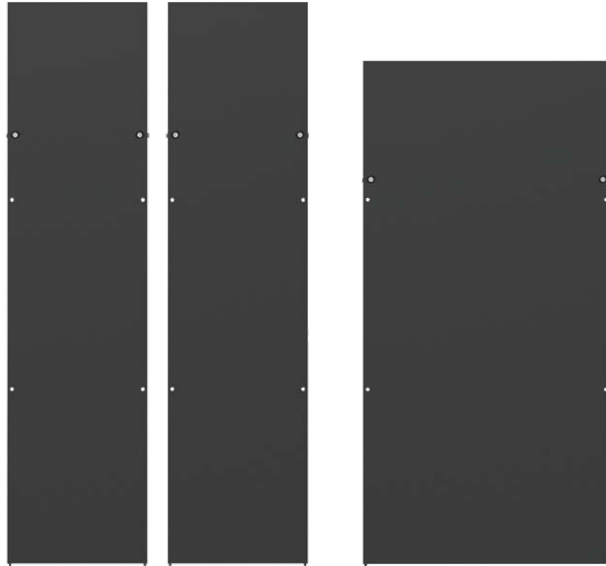

WZ-8848-24-4712-161
Two-parts partition panel
for cabinet SZBIT 47 U , 1200 mm deep

WZ-8848-24-4210-161
Partition panel
for SZB IT 42 U , 1000 mm deep

Set for baying SZB IT cabinets in rows

Set of elements for baying SZB IT cabinets.
One set is intended for baying two cabinets.

Material

Al-Zn coated sheet steel.

Scope of delivery

4 clamp connectors, 4 bolts M8 with nut.

Package	Catalogue number
1 set	WZ-8848-23-00-000



Baying frame posts
without partition panel

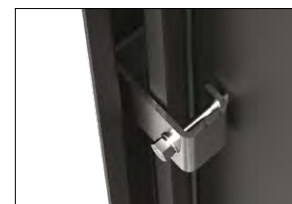

Baying frame posts
with partition panel

SZB/DSR IT 19" SERVER CABINETS

COLD AISLE INSTALLATIONS



WZ-8848-50-06-161
Cold aisle cover for Data Box set 47 U with feet and raised roof

Cold aisle cover

It is an optional solution instead of sliding doors. Designed for cold aisle **1200 mm** wide.

Material

Sheet steel powder painted in light grey (RAL 7035) or black (RAL 9005).

Scope of delivery

Cold aisle cover, aisle roof masking panel, sealing (for set on feet only), fixing accessories.



Data Box set 47 U with feet, raised roof and cold aisle cover

For Data Box with cabinets' height	Catalogue number			
	Cover for aisle with raised roof		Cover for aisle with flat roof	
	RAL 7035	RAL 9005	RAL 7035	RAL 9005
42 U without feet or plinth	WZ-8848-50-01-011	WZ-8848-50-01-161	WZ-8848-50-10-011	WZ-8848-50-10-161
47 U without feet or plinth	WZ-8848-50-03-011	WZ-8848-50-03-161	WZ-8848-50-12-011	WZ-8848-50-12-161
42 U with feet	WZ-8848-50-04-011	WZ-8848-50-04-161	WZ-8848-50-13-011	WZ-8848-50-13-161
47 U with feet	WZ-8848-50-06-011	WZ-8848-50-06-161	WZ-8848-50-15-011	WZ-8848-50-15-161
42 U with plinth	WZ-8848-50-07-011	WZ-8848-50-07-161	WZ-8848-50-16-011	WZ-8848-50-16-161
47 U with plinth	WZ-8848-50-09-011	WZ-8848-50-09-161	WZ-8848-50-18-011	WZ-8848-50-18-161

Package: 1 set

SERVER CABINETS **SZB/DSR IT 19"**

COLD AISLE INSTALLATIONS

Sealing masking strip for cabinet on feet

Sealing masking strip protects from getting cold air from the aisle to the space under the cabinet.

Material

Sheet steel powder painted in light grey (RAL 7035) or black (RAL 9005), black plastic.

Scope of delivery

Sealing masking strip with fixing accessories.

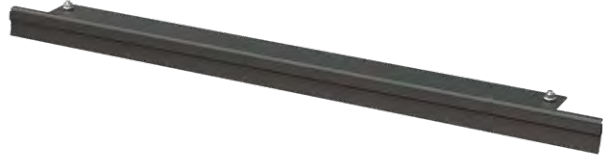

For cabinets' width [mm]	Catalogue number	
	RAL 7035	RAL 9005
800	WZ-8848-27-01-011	WZ-8848-27-01-161
600	WZ-8848-27-02-011	WZ-8848-27-02-161

Package: 1 pc



Cabinet equipped with sealing masking strip

Aisle lightening

Aisle can be equipped with modular lightening.

Available on request.



Example of light fittings mounted under the roof of the aisle

Cable trays systems

Data Box set can be equipped with cable trays system assembled on cabinets.

Available on request.

